

227CA
(1T-227)

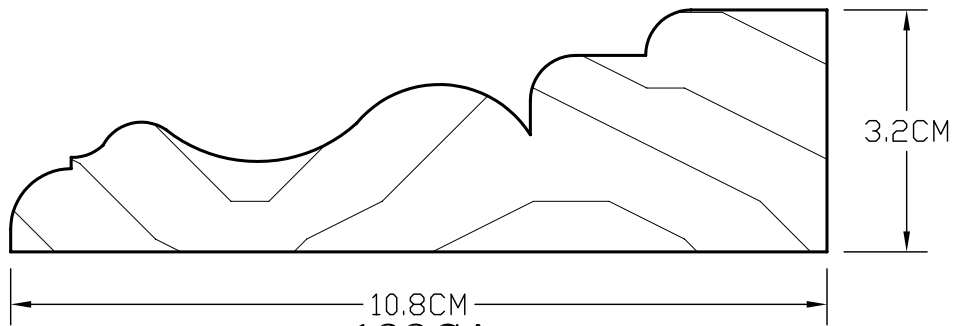

199CA
(1T-199)

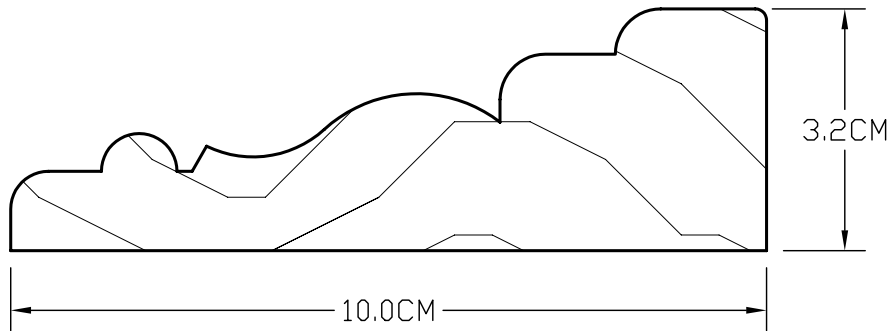

203CA
(1T-203)

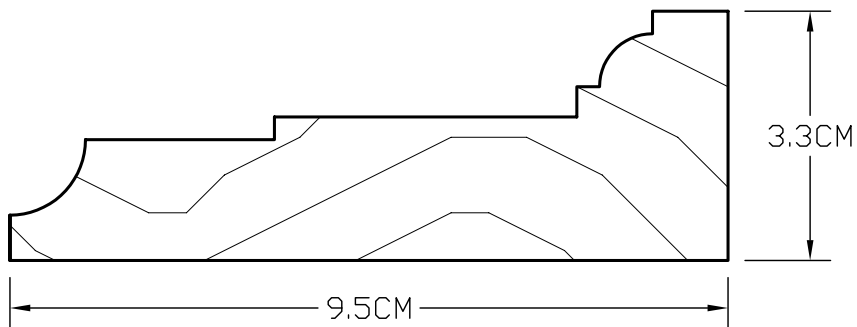

200CA
(1T-200)

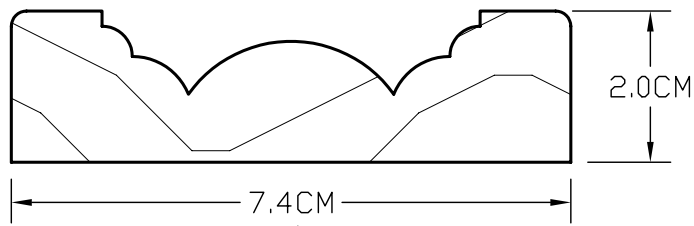
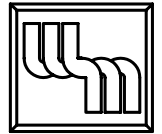

035CA
(1T-035)

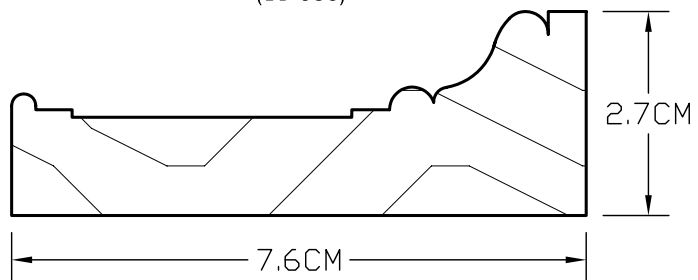

222CA
(1T-222)

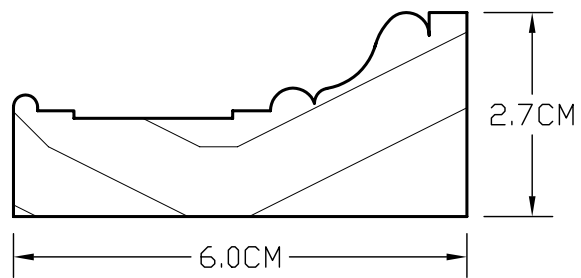

261CA
(1T-261)

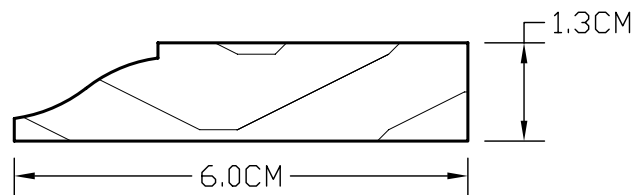

260CA
(1S-260)

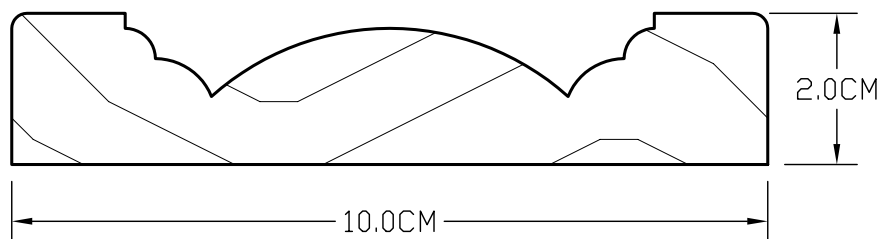

032CA
(1T-032)

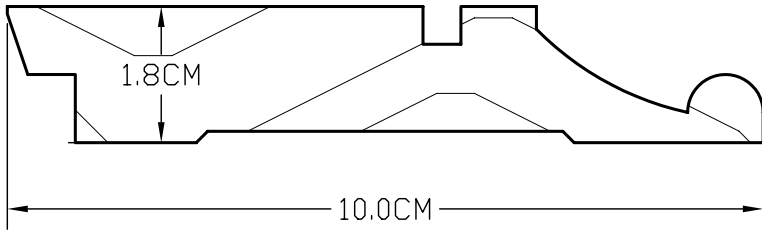
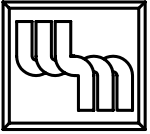

103CA
(1S-1T-103)

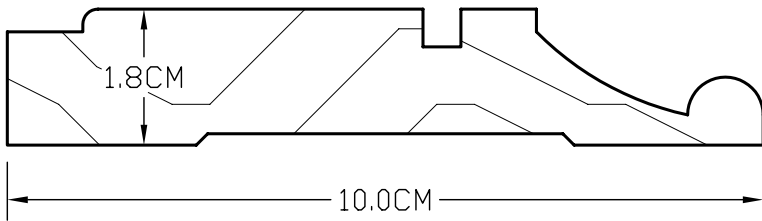

104CA
(1S-1T-104)

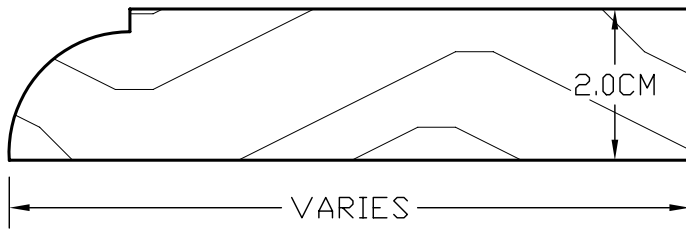

093CA
(1S-093)

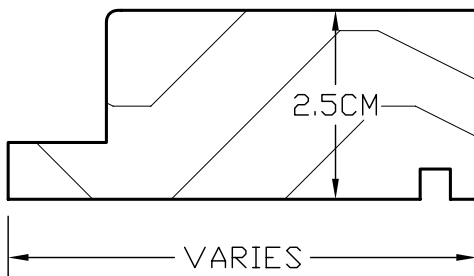

127CA
(1S-1B-127)

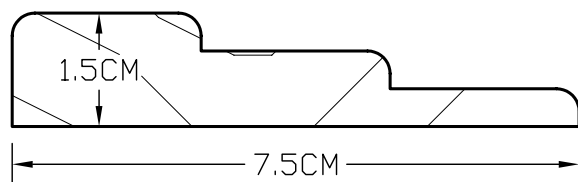

175CA
(1T-175)

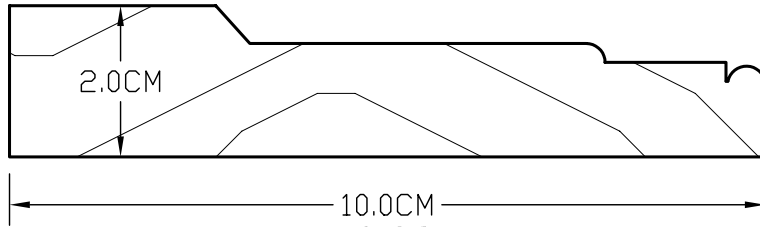
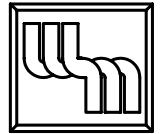

186CA
(1T-186)

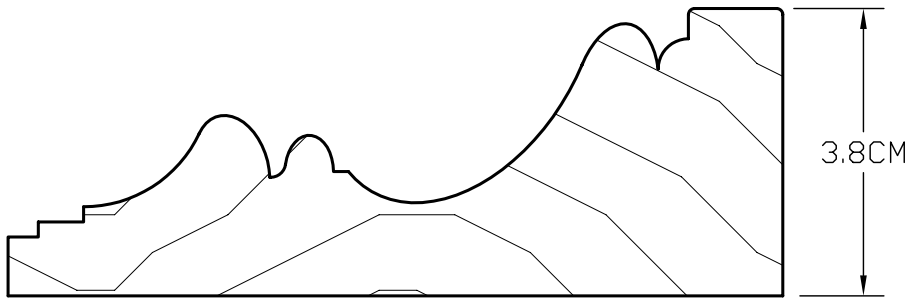

178CA
(1T-178)

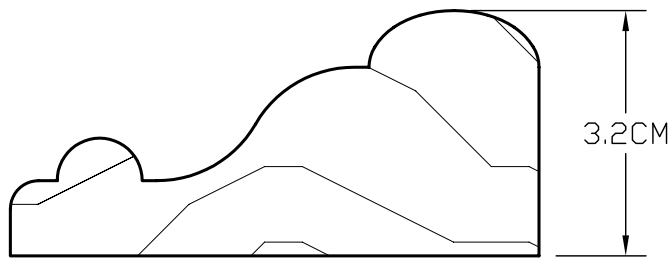

174CA
(1T-174)

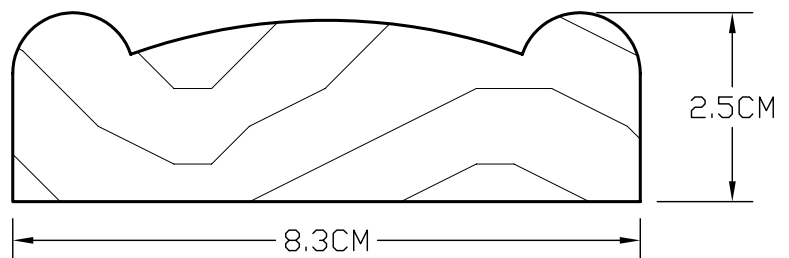

170CA
(1T-170)

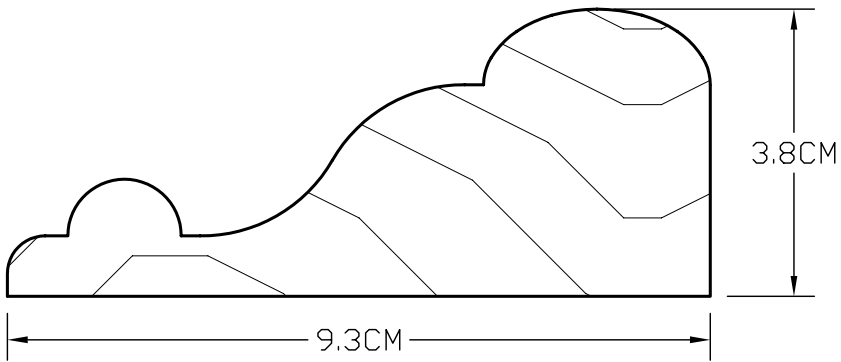
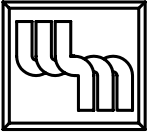

165CA
(1S-1T-165)

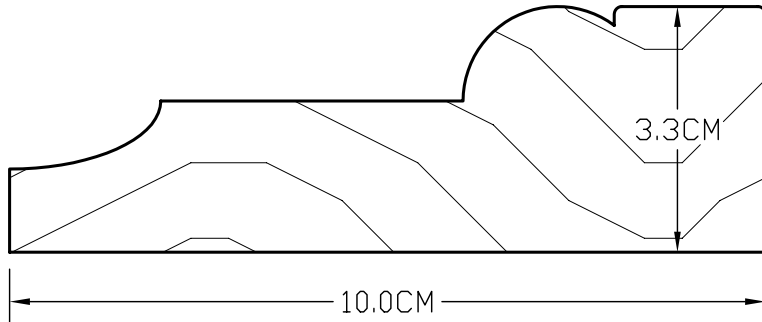

154CA
(1T-154)

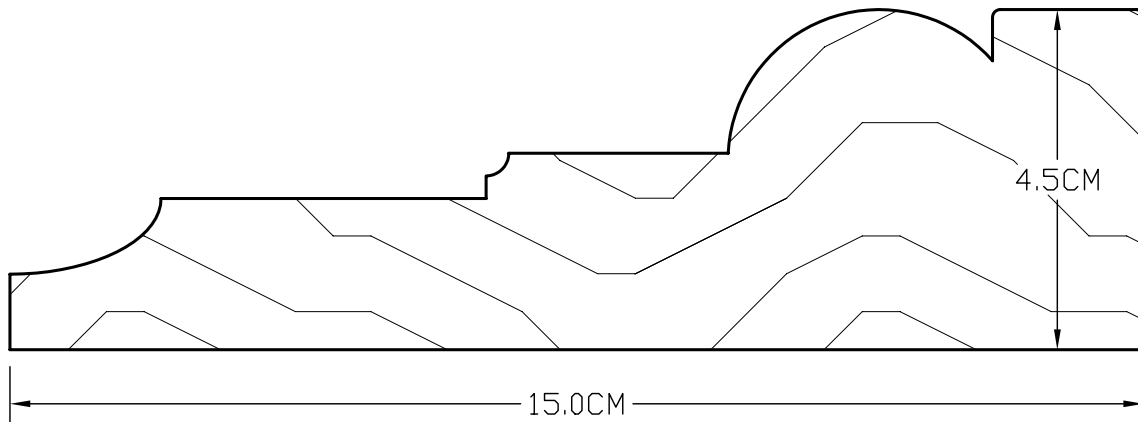

155CA
(1T-155)

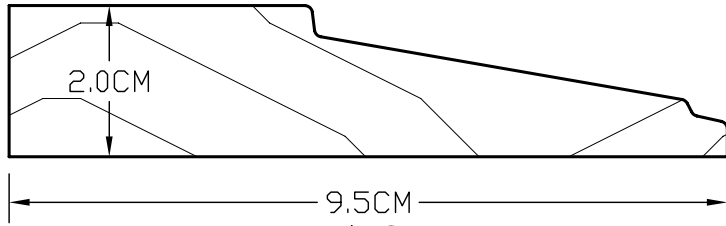
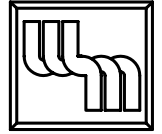

147CA
(1T-147)

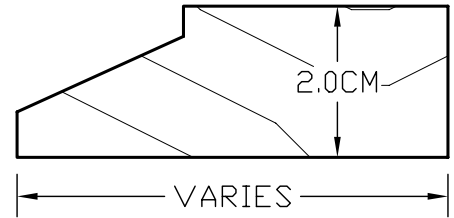

VARIES
303CA
(1S-303)

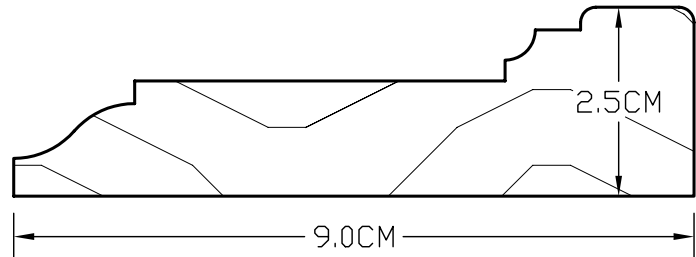

081CA
(1T-081)

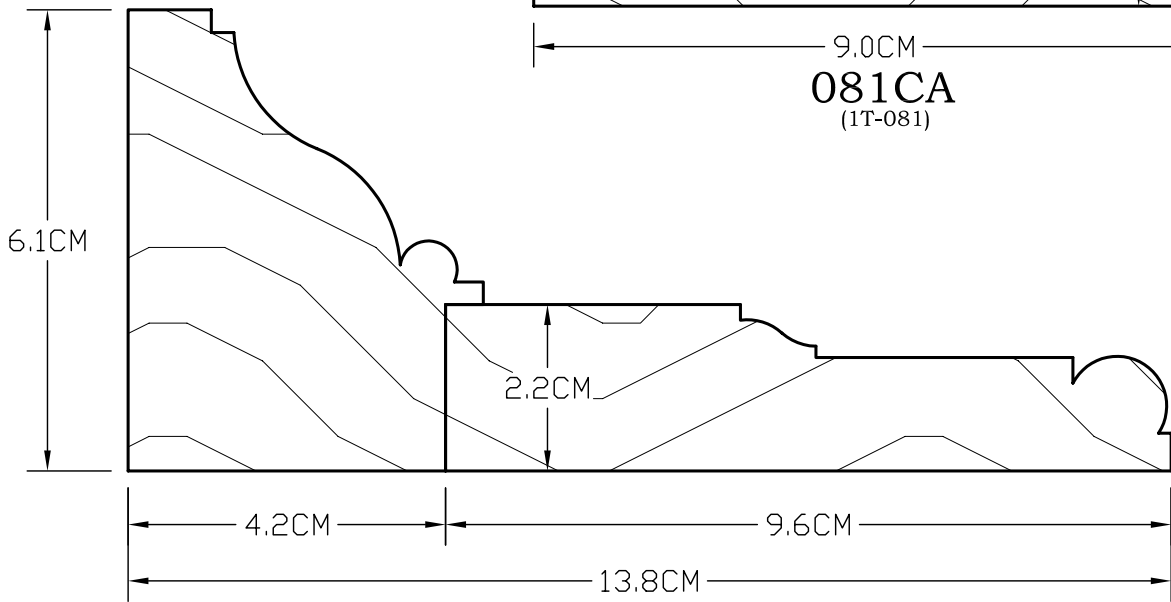

298CA
(1S-1T-298)

299CA
(1S-1T-299)

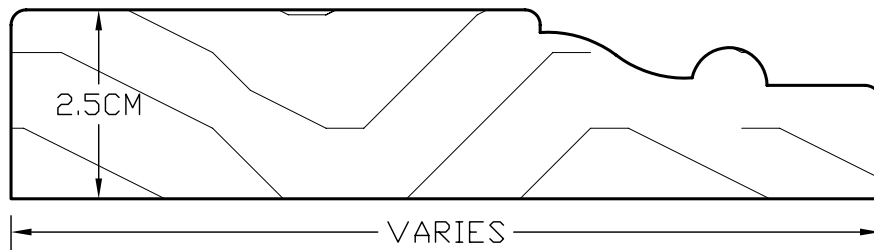

VARIES
130CA
(1T-130)

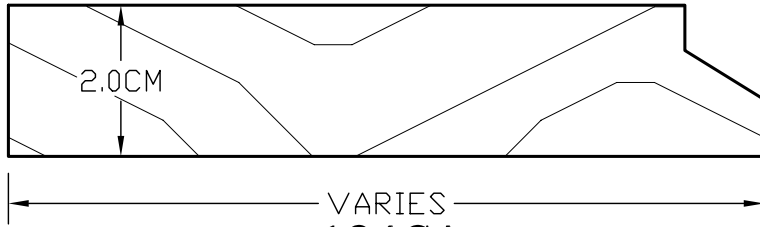
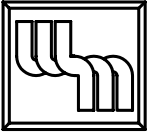

124CA
(1S-124)

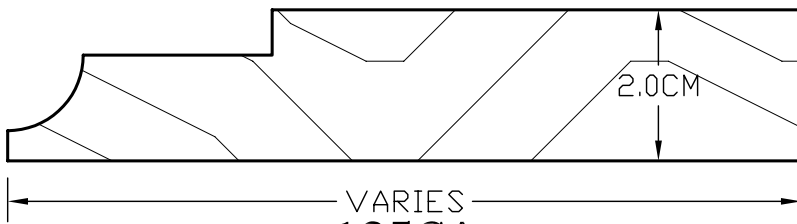

125CA
(1T-125)

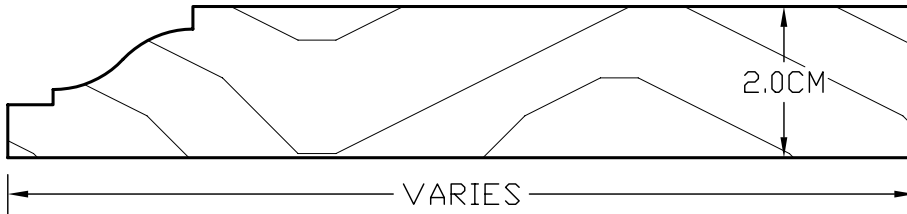

085CA
(1S-085)

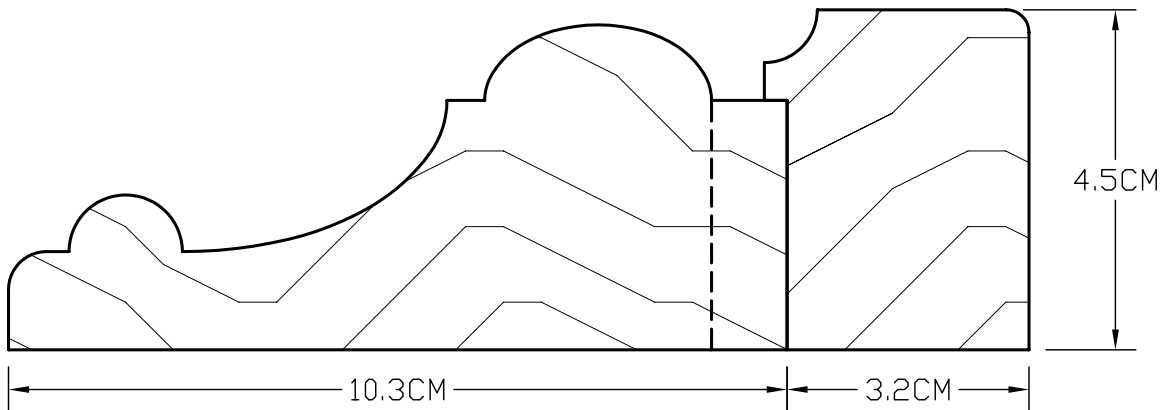

064CA
(1T-064)

065CA
(1S-1T-065)

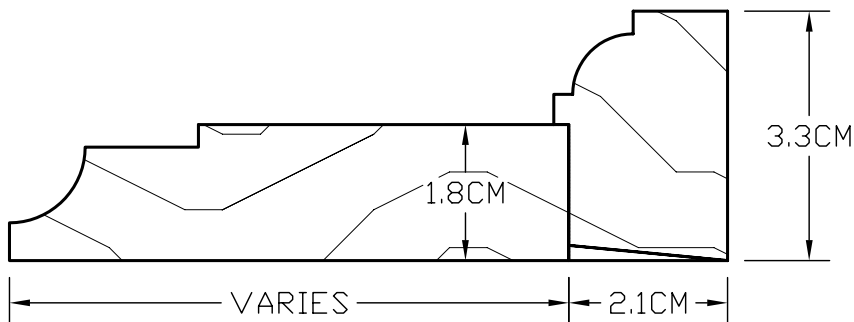
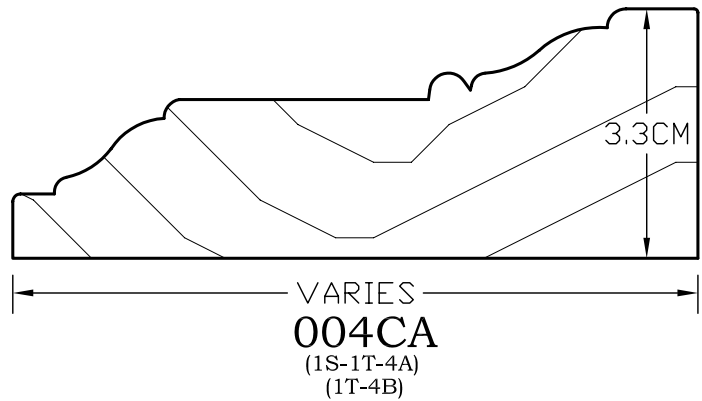
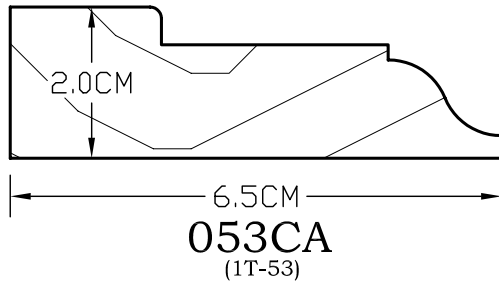
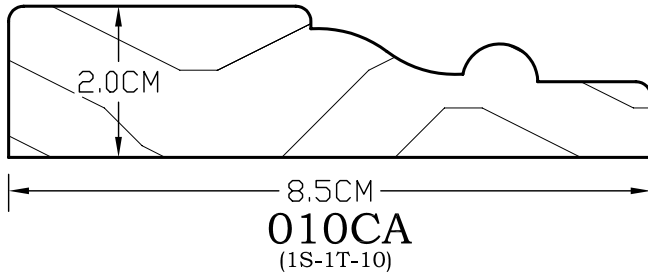
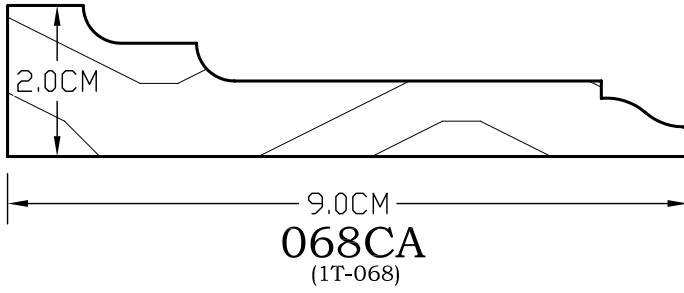
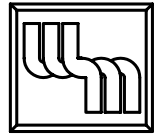

018CA
(1T-18A) 1 PC
(1T-18B)
(1S-1T-18C) 2 PC

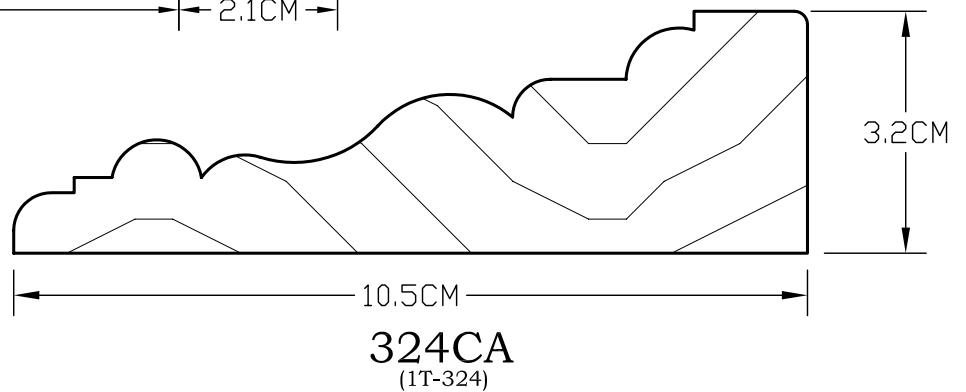

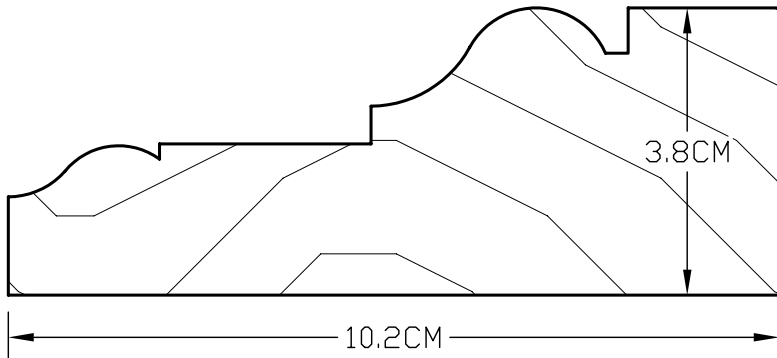
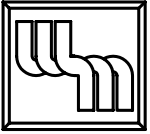

327CA
(1T-327)

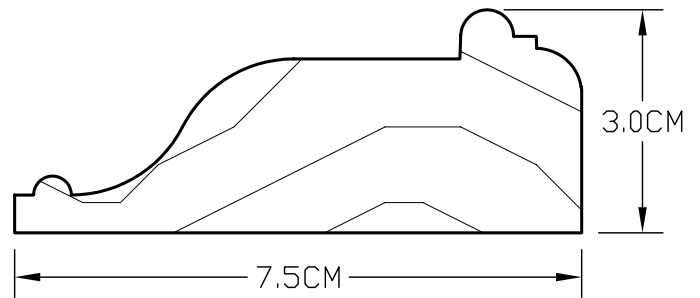

346CA
(1T-346)

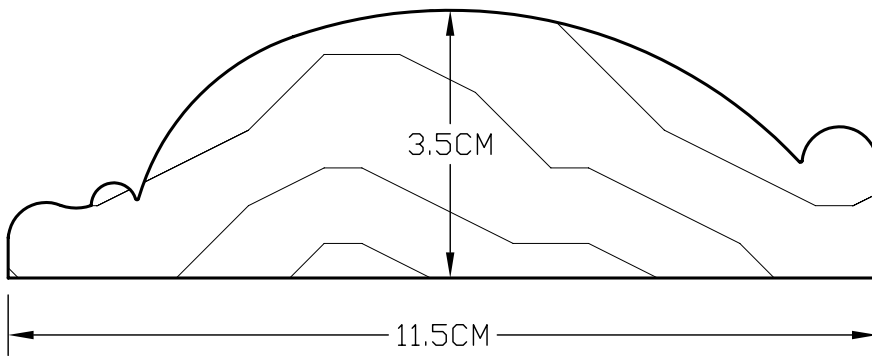

343CA
(1T-343)

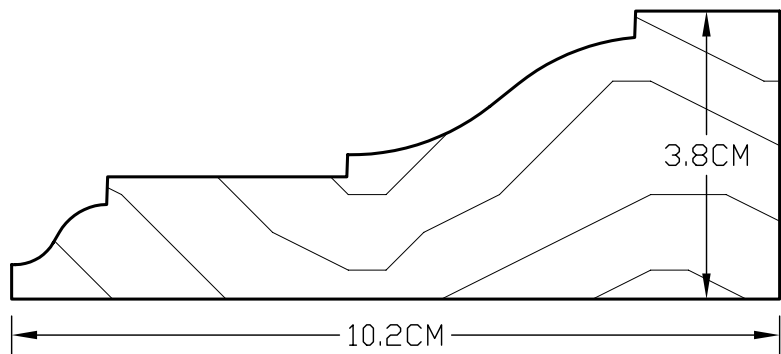

356CA
(1T-356)

